

MIPRO®

MA-505

Portability

Simplicity

Flexibility

Portable Wireless PA System

User Guide



MIPRO Electronics Co., Ltd

Headquarters: No. 814, Beigang Rd., Chiayi City 600079, Taiwan

Tel : +886.5.238.0809 Fax : +886.5.238.0803

www.mipro.com.tw mipro@mipro.com.tw

Specifications and design subject to change without notice.

Do not copy or forward without prior approvals of MIPRO.

All rights reserved. YM 022/10



2005-08-15

FC

CE

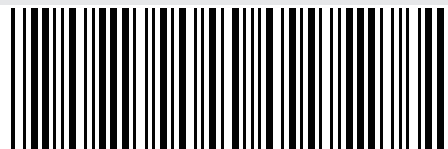

2CE591C

Portable Wireless PA System

I. Part Names

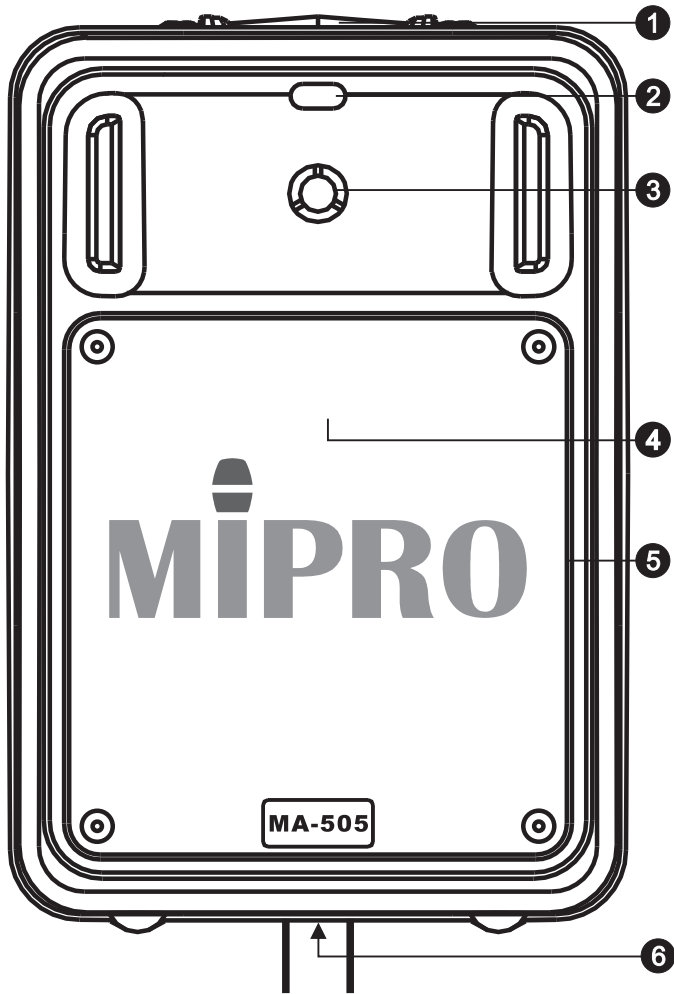

Fig. 1: Front Panel

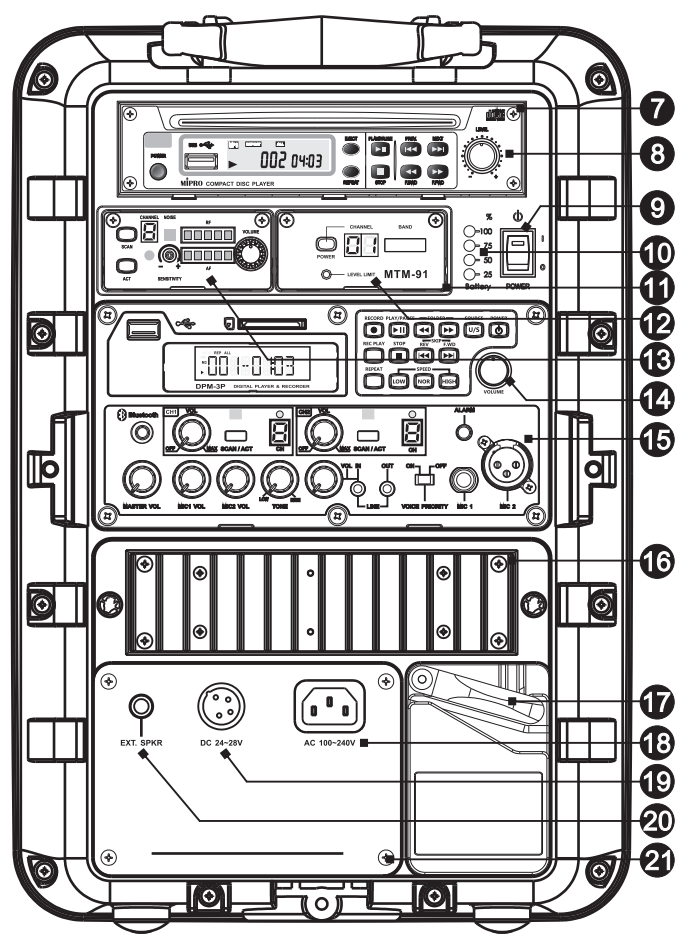

Fig. 2: Rear Panel

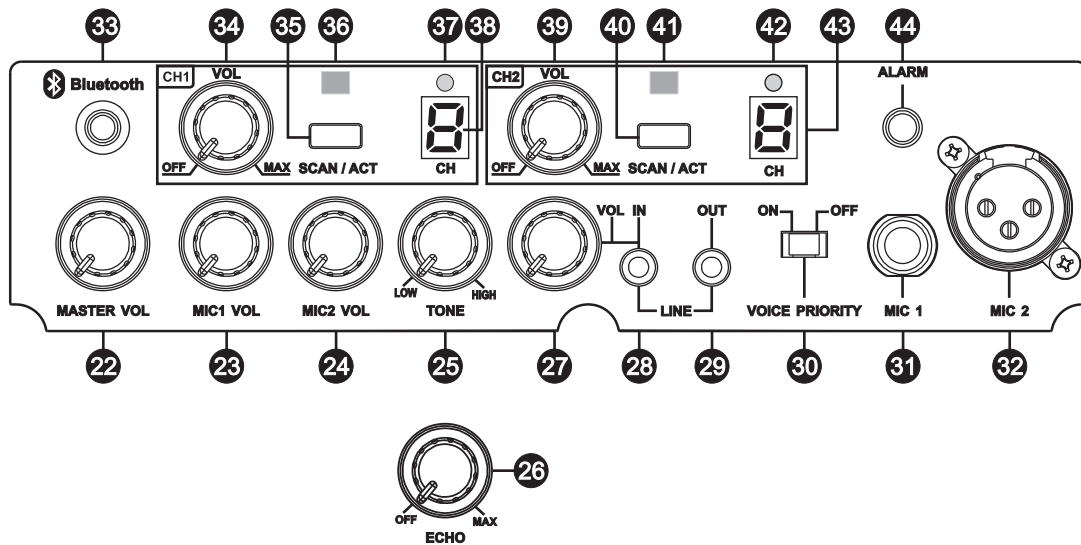

Fig. 3: Control Panel

Portable Wireless PA System

Front Panel. Fig. 1

- ① Fixed Handle
- ② Remote Control Port
- ③ Treble Speaker
- ④ Bass Speaker
- ⑤ Speaker Grille
- ⑥ Tripod Stand Mount

Rear Panel. Fig. 2

- ⑦ Optional CD/MP3 Media Player Module Frame
- ⑧ Optional CD/MP3 Media Player
- ⑨ Master Power Switch
- ⑩ Battery Meter Indicators
- ⑪ Optional Receiver or Interlinking Transmitter Module Frame
- ⑫ Optional Receiver or MTM-91 Interlinking Transmitter Module
- ⑬ Optional Wireless Receiver Module(s)
- ⑭ DPM-3P Digital Audio Recorder Module
- ⑮ Control Panel
- ⑯ Heat Sink
- ⑰ Storage Lever
- ⑱ AC Power Input Socket
- ⑲ DC Power Input Jack
- ⑳ Extension Speaker Input Jack
- ㉑ Battery Cover

Control Panel. Fig. 3

- ㉒ MASTER Volume Control
- ㉓ MIC 1 Volume Control
- ㉔ MIC 2 Volume Control
- ㉕ TONE Control
- ㉖ ECHO Control (optional)
- ㉗ LINE IN Volume Control
- ㉘ LINE IN 3.5 Ø Jack
- ㉙ LINE OUT 3.5 Ø Jack
- ㉚ Voice over Music Priority Switch
- ㉛ MIC1 Wired Microphone Input Socket (6.3 Ø / 1/4" Unbalanced)
- ㉜ MIC2 Wired Microphone Input Socket (XLR Balanced)
- ㉝ Bluetooth® Power Button & Indicator
- ㉞ CH1 VOL: Powers receiver on/off and wireless CH1 volume
- ㉟ CH1 SCAN/ACT Button
- ㊱ CH1 Sync Port
- ㊲ CH1 RF Indicator
- ㊳ CH1 Channel Screen
- ㊴ CH2 VOL: Powers receiver on/off and wireless CH2 volume
- ㊵ CH2 SCAN/ACT Button
- ㊶ CH2 Sync Port
- ㊷ CH2 RF Indicator
- ㊸ CH2 Channel Screen
- ㊹ Alarm Siren Button

II. Operating Instructions

1. Power On

Minimize all volume levels before turning on the Master Power Switch ⑨. A fully lit Battery Status Indicators ⑩ indicates the rechargeable battery is fully charged. A single red color indicator indicates the rechargeable battery is low on power. Simply plug the supplied power cord into the power socket on the back and the other end into an AC power outlet to recharge the battery.

2. LINE IN ⑳ and LINE OUT ㉑ 3.5 Ø Jack

- (A) Reduce the Line Input volume levels ㉒ to minimum. Once powered on, adjust Master Volume levels ㉓ to maximum, and adjust line input volume to appropriate level.
- (B) Line Output jack ㉑ combines all mixed audio. Volume levels are individually adjusted, and not related to master volume control.

3. Wired Microphone

- (A) Reduce microphone volume levels to minimum. Once powered on, adjust Master Volume Control ㉓ to maximum.
- (B) Plug an unbalanced 6.3 Ø microphone into Unbalanced 6.3 Ø Microphone Input ㉔ and adjust MIC 1: Unbalanced 6.3 Ø Microphone Input Volume Control ㉕.
- (C) Plug a balanced XLR microphone into Balanced XLR Microphone Input ㉖ and adjust MIC 2: Balanced XLR Microphone Volume Control ㉗.
- (D) Tone Control ㉘ for high/low or Echo Control ㉙ effect adjustments.
- (E) The Voice over Music Priority ㉚ feature mutes the volume of the played audio when it is switched to on and microphone is used. Feature is disabled when it is switched to off.
- (F) The wired and wired microphones can be used at the same time and sound can be heard simultaneously.

4. Wireless Microphones

- (A) Reduce microphone volume levels to minimum. Once powered on, adjust Master Volume Control ㉓ to maximum.
- (B) Power on CH1 VOL ㉜ or CH2 VOL ㉝. CH1 or CH2 Channel Screen ㉞ ㉟ glows.
- (C) Power on CH1 or CH2 transmitter, the RF Indicator ㊱ or ㊲ glows.
- (D) Adjust CH1 VOL ㉜ or CH2 VOL ㉝ to the desired volume levels.
- (E) Wireless microphones and other audio sources are workable simultaneously.
- (F) Both wired and wireless microphone has the echo and voice over music priority functions.
- (G) Do not turn on more than 1 wireless microphone on the same channel. Only one transmitter can be used at a time on that channel. Same wireless microphone can transmit to multiple MA-505 systems on the same channel for a wider and expanded coverage.
- (H) Power off CH1 VOL ㉜ or CH2 VOL ㉝ when the wireless microphone is not used.
- (I) Operating Instructions of Changing Channels
 - (1) Scan automatically for a Non-interference Receiver Channel: Press and hold SCAN / ACT Button ㉛ or ㉜ to perform a channel scan. Existing channel blinks to denote it is ready to accept parameter changes. If SCAN / ACT Button is not pressed within ten blinks, it stops blinking and reverts back to the existing channel. During blinking, press and release button to scan and stop for an open channel. This new channel is now saved. Fig. 4.

Portable Wireless PA System

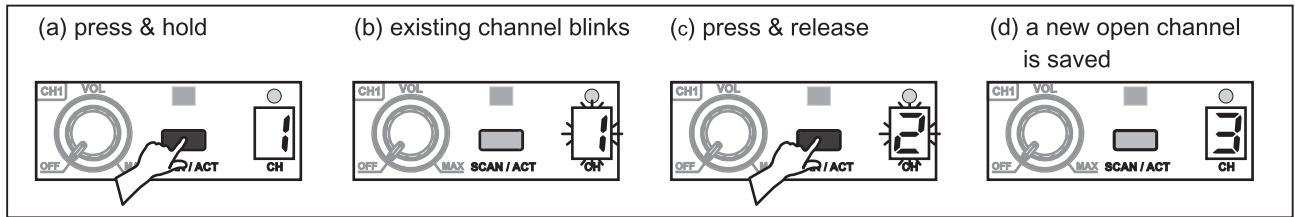

Fig. 4

- (2) Manually Search for a Receiver Channel: Press and hold SCAN / ACT Button to perform a manual channel search. Existing channel blinks to denote it is ready to accept parameter changes. During blinking, press and hold SCAN / ACT Button to force the channel to go forward to the next channel in order. Release SCAN / ACT Button until a desired channel is located. This new channel is now saved. Fig. 5.

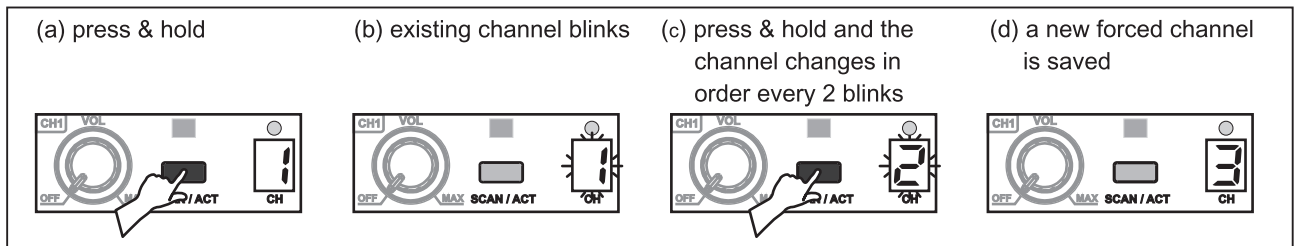

Fig. 5

(J) Reason for Changing a new Channel:

- (1) Noise or interference is heard during a presentation or performance.
- (2) When two or more receiver modules are installed, therefore, two or more compatible channels are required to be used simultaneously.

(K) Caution:

- (1) Do not attempt to change a new channel during a performance where two or more transmitters/microphones are being used simultaneously to avoid interferences with each other generated by the transmitting microphone signals.
- (2) “_” denotes this channel is currently experiencing interference; therefore, it should be avoided.

(L) ACT Channel Synchronization:

- (1) Ascertain both the receiver and the transmitter are powered on. Press ACT Button 35 or 40 on the receiver to activate IR (infrared) channel synchronization. Existing channel blinks 38 or 43 .
- (2) Align the ACT sync windows of both transmitter and receiver within 30 cm of each other for automatic channel synchronization. Fig. 6.
- (3) If ACT channel synchronization is performed successfully, the new channel stops blinking, RF indicators are lit.

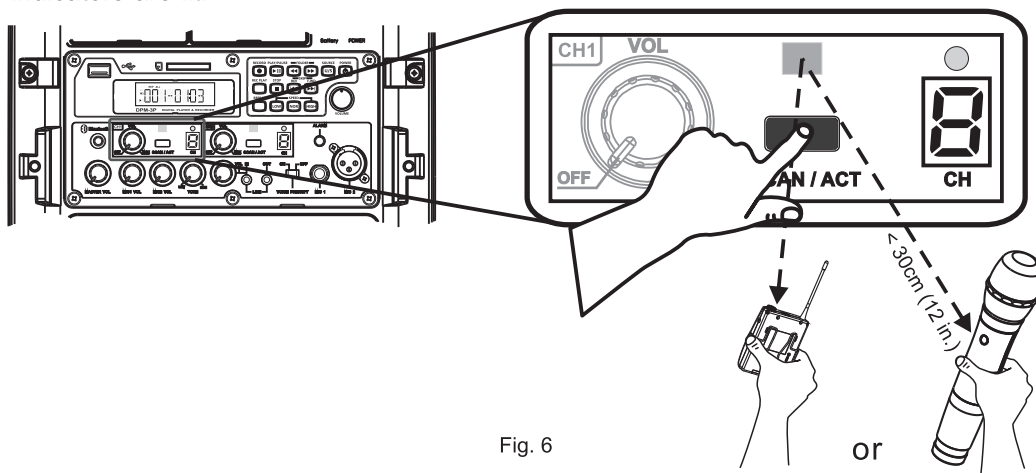



Fig. 6

Portable Wireless PA System

5. Pairing Bluetooth® Receiver

- (A) Power on the Bluetooth receiver and bring the mobile device within reception range.
- (B) Press & hold the Bluetooth Power Button & Indicator  for 3-5 seconds until blue/red indicator  light is flashing intermittently to indicate the receiver is now ready to be paired.
- (C) If the indicator is not flashing intermittently or not flashing, repeat by press & hold for 3~5 seconds until blue/red indicator is flashing intermittently.
- (D) Search Bluetooth devices and click on "MIPRO MB-xx" for receiver ID. Enter "0000" when prompted to enter a PIN code. This will cause your device to pair with the Bluetooth receiver.
- (E) Once paired and connection is made, the blue color indicator lights on. You can play the music on your device.
- (F) To cancel Bluetooth function by press & hold Bluetooth Power Button & Indicator for 3 seconds.
- (G) Power off and on the Bluetooth receiver for changing connected device. Repeat the directions in "Pairing Bluetooth® Receiver" to connect a different device.
- (H) Pairing Bluetooth® for two devices:
Turn on one device first and operate steps A~E, then turn on the other one and do step B. Press the Bluetooth button twice for each device, during blue/red indicator light flashing intermittently, two Bluetooth receivers are pairing with each other. Once paired, the blue color indicator light will flash intermittently or stay on. Now play the music from the paired smartphone and get stereo sound amplification.

III. Connection for External Audio Sources. Fig. 7

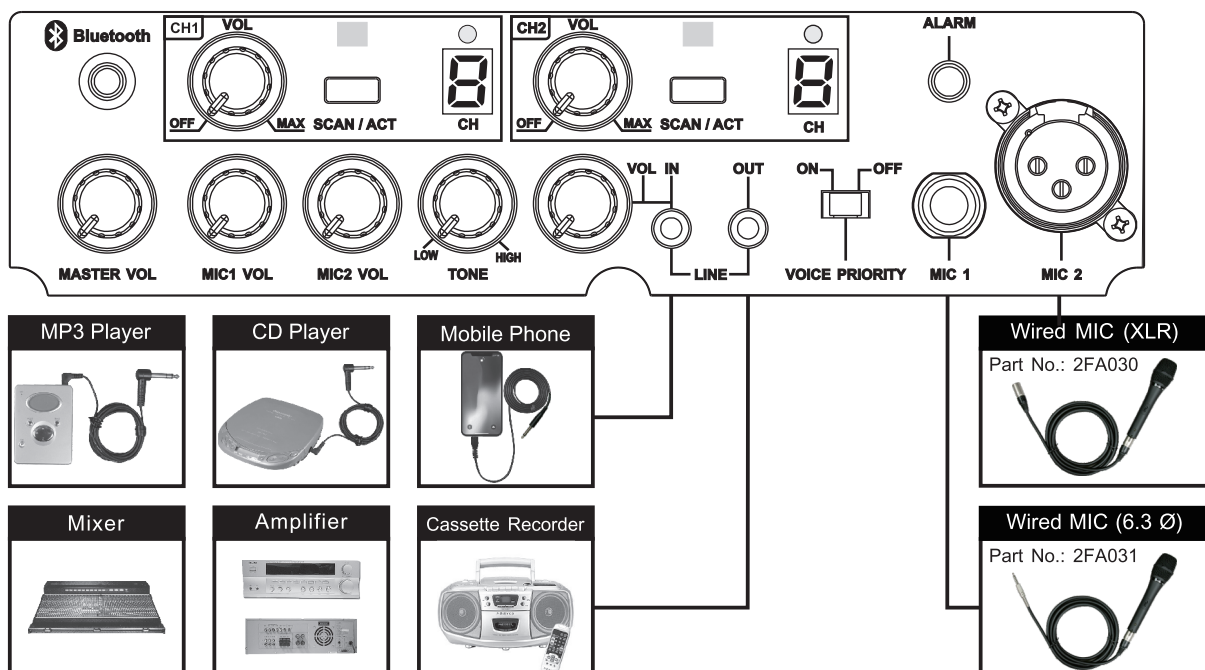

Fig. 7

IV. Storing Power Plug and Cord. Fig. 8

1. Push the Storage Lever 17 up to remove the lid plate.
2. Insert the power cord into the storage.
3. Put the lid plate back and adjust the lever to close the lid plate tightly.

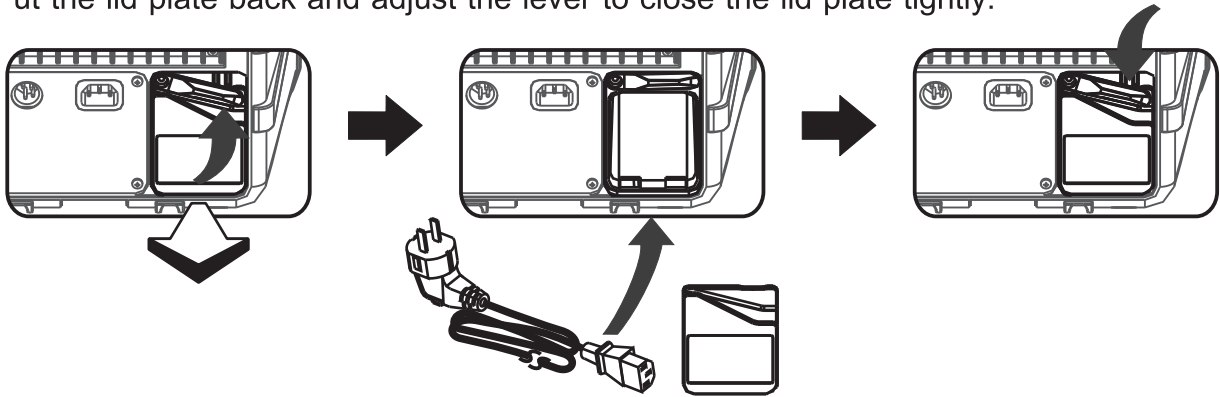

Fig. 8

V. Replace Battery. Fig. 9

1. Remove screws from Battery Cover 21 plate by using a Phillips-head screwdriver (not supplied).
2. Slide the battery away and remove the wire.
3. Connect the wire of the new battery and insert the connected battery into the compartment.
4. Put the cover plate back and fasten the screws.

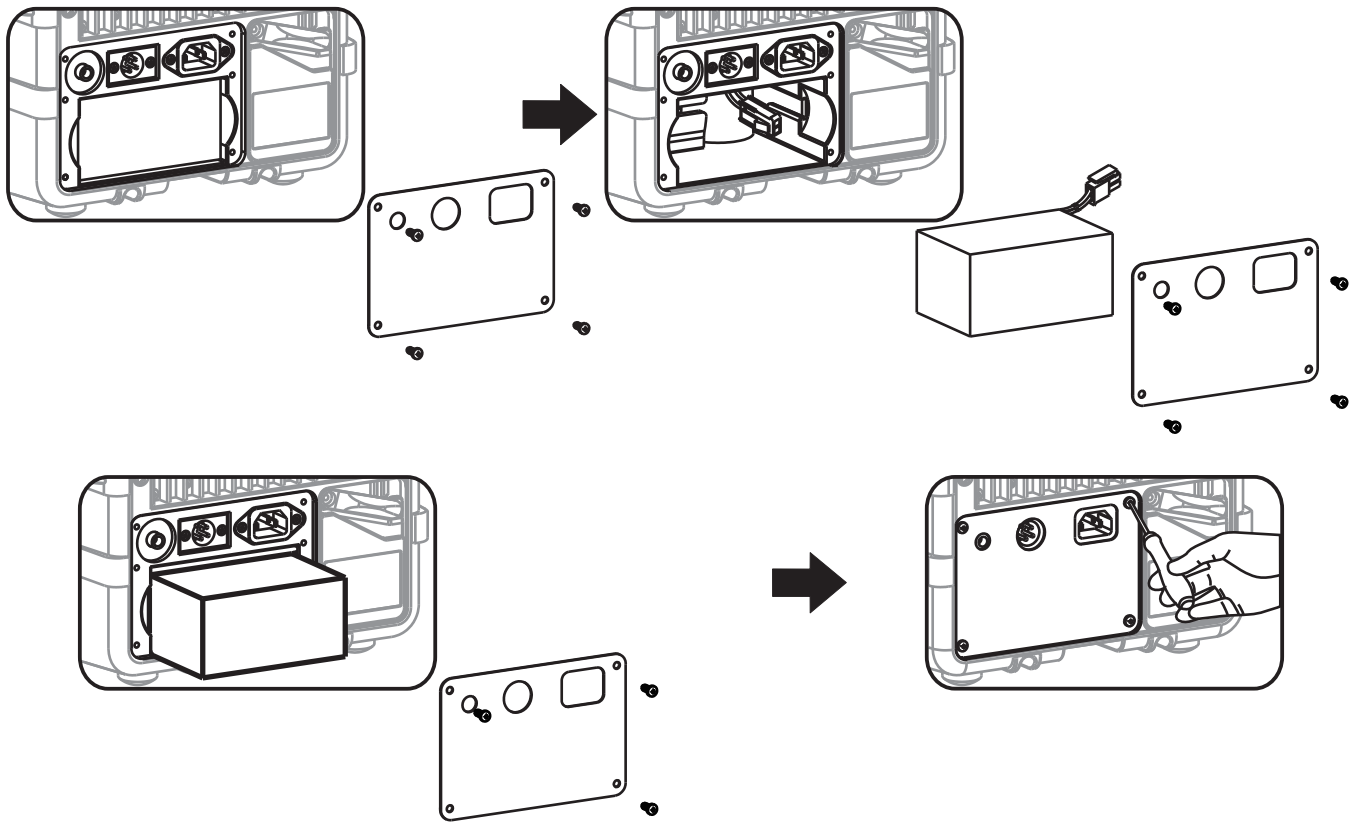

Fig. 9

VI. Power Usage Instruction

1. How to use AC power input

- (A) After putting the power plug into the AC Power Input Socket 18 of the device, the 4 Battery Meter Indicators 10 will glow immediately, no matter if the power switch is on or off. This means that the built-in switching power supply is functioning normally and the built-in rechargeable batteries are fully charged. If the battery meter indicators are blinking this means that the built-in switching power supply is working normally and the built-in rechargeable batteries are in an under charged condition. After a couple of minutes, the battery meter indicators will stop blinking and continue a glowing condition, indicating the batteries are now fully charged.
- (B) When using the AC power, you can remove or plug the power cord freely with no need to turn off the power switch first. If or when an unfortunate power cut happens during usage, the MA-505 will activate the DC power automatically to maintain continuous operation.

2. How to use DC power input

- (A) When the built-in lithium battery is fully charged, the unit can be operated continuously for approximately 8 hours in standby mode (CD player and two receivers are turned on); 7 hours for audio and 6 hours for music. (The above figures are references for brand new batteries only)
- (B) Use the built-in AC power supply to recharge.
- (C) In the case of no AC power connection, if the Power Switch 9 is not turned on, the Battery Meter Indicators 10 will not be shining. When the power switch is turned on, the red LED on it will be shining; meanwhile, if 2 to 4 battery meter indicators are shining, it means the battery power is enough for normal operation. If only 1 red LED is shining or the red LED on the power switch is flashing, it means the battery power is insufficient and immediate charge is necessary. If no battery meter indicators are shining after the power switch is turned on, it means the batteries are completely discharged or possibly faulty.
- (D) Always store MA-505 system with the batteries fully charged if needing to store the system for more than 3 months. Leave the system plugged into an AC power outlet when not in use.

3.  AC power and DC power can not be used at the same time.

4. A connector is included which allows users to make DC wiring. See diagram below for illustration:

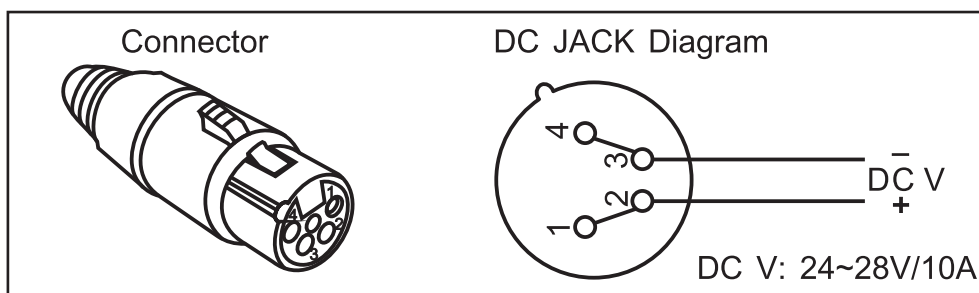

Fig. 10

VII. Installation of Wireless Receiver Modules

1. MA-505 has 2 built-in receiver modules. Up to 2 additional receiver modules can be installed.

2. MA-505 doesn't have master volume remote control function.

3. Installation or replacement of wireless receiver modules. Fig. 11.

(A) Power off the system first.

(D) Insert the receiver module.

(B) Remove the 2 screws on the receiver module.

(E) Push in and align the edge connectors firmly and tightly.

(C) Remove the front blank plate.

(F) Fasten the screws tightly.

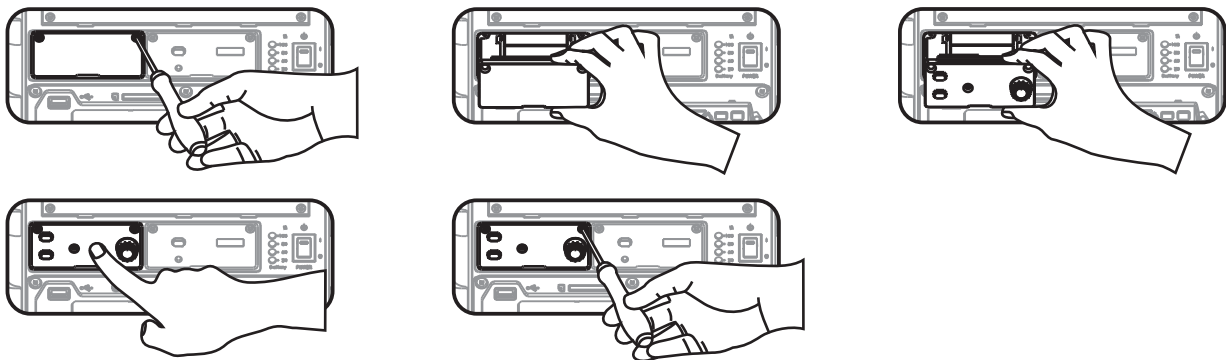

Fig. 11

4. Operations of wireless receiver modules: Refer to its user guide.

VIII. Installation of Wireless Interlinking Transmitter

1. User can install one MTM-91 interlinking transmitter on MA-505.

2. Installation. Fig. 12.

(A) Power off the system first.

(D) Insert the Interlinking Transmitter module horizontally.

(B) Remove screws from blank panel.

(E) Gently push in until it is aligned into place.

(C) Remove blank panel.

(F) Tighten the screws.

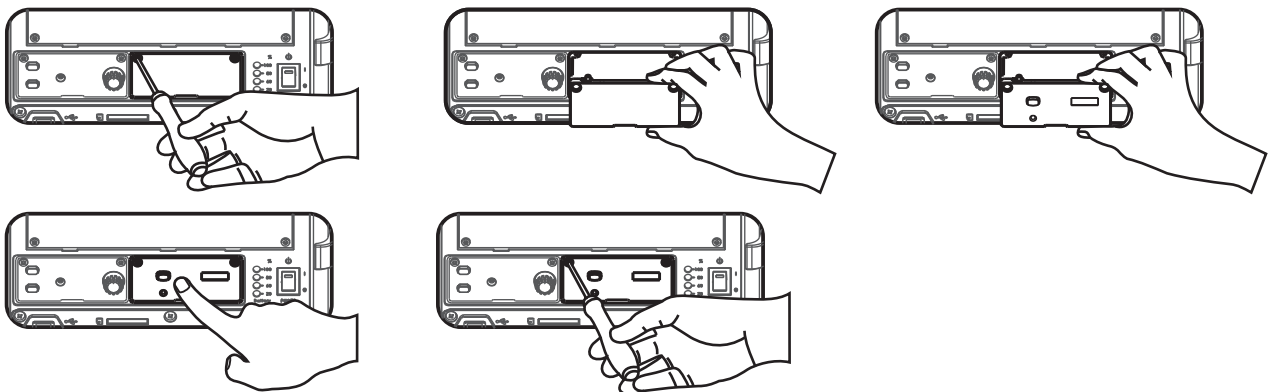

Fig. 12

3. Operating instructions of MTM-91 wireless interlinking transmitter: refer to its user guide.

IX. Installation of MIPRO DPM-3P Media Player

1. Part Names. Fig. 13, 14:

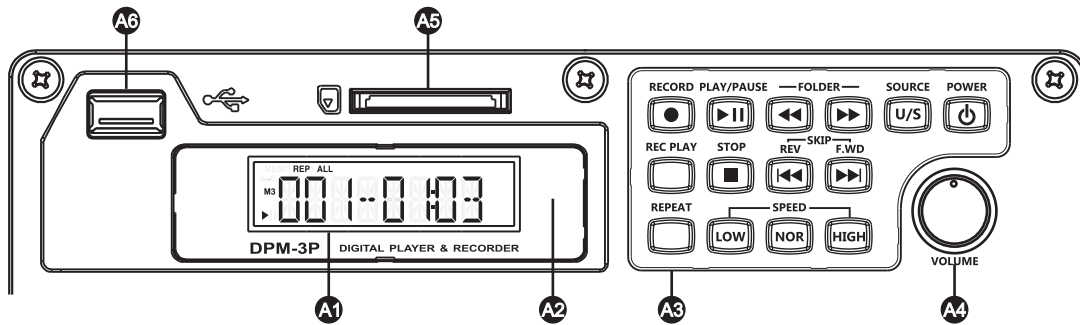

Fig. 13: Front Panel

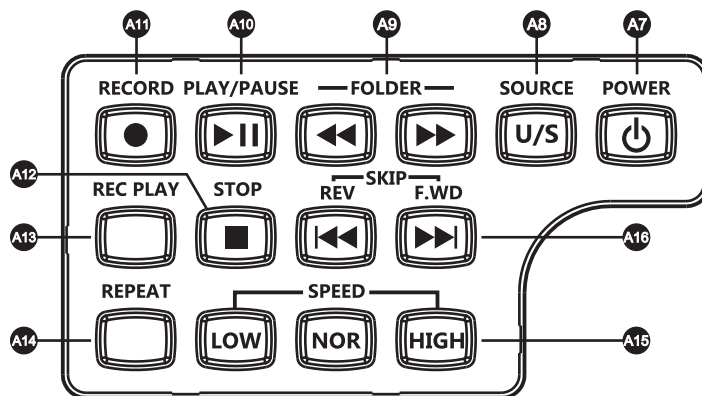

Fig. 14: Control Panel

Front Panel, Fig. 13

- | | | |
|------------------------|------------------|-----------------|
| Ⓐ1 LCD Display Screen | Ⓐ3 Control Panel | Ⓐ5 SD Card Slot |
| Ⓐ2 Remote Control Port | Ⓐ4 Volume Knob | Ⓐ6 USB Port |

Control Panel, Fig. 14

- | | |
|----------------------------|--|
| Ⓐ7 POWER | Ⓐ13 REC PLAY |
| Ⓐ8 SOURCE Mode button | Ⓐ14 REPEAT |
| Ⓐ9 FOLDER Selection button | Ⓐ15 SPEED |
| Ⓐ10 PLAY/PAUSE | Ⓐ16 SKIP: F.WD ►► Forward to the next track. REV ◀◀ Backward to the last track. Long press to fast forward / backward to the next / last tracks. |
| Ⓐ11 RECORD | |
| Ⓐ12 STOP | |

2. Operating Instructions:

(A) Media Slots. Fig. 15:

- (1) USB Disk: Insert USB 2.0 into the USB port for playing MP3 / WMA / FLAC / APE / WAV / M4A / AAC / OGG files.
- (2) SD Card Reader: Insert a SDHC card with gold contacts facing up and label facing down. Press it again to pop out.
- (3) Format USB and SD card before playback. Format standard is FAT.
- (4) Press SOURCE Mode button Ⓐ8 to select USB or SD card. USB plays first prior to SD card.
- (5) NO DISK displays when it is unable to detect or read a media source.

Portable Wireless PA System

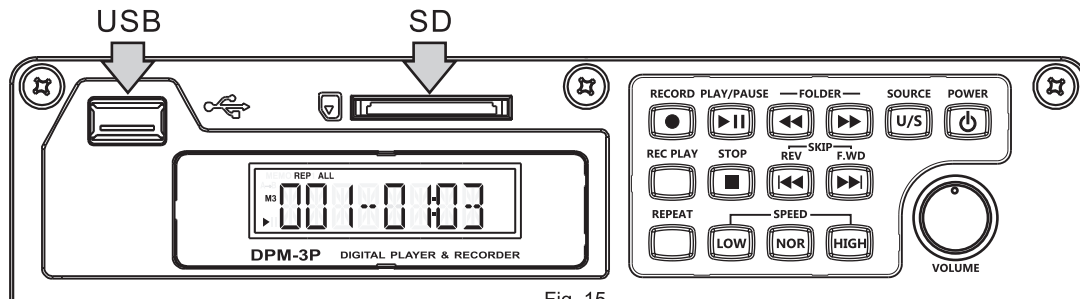

Fig. 15

(B) Music Playback:

- (1) Press PLAY/PAUSE **A10** for playback. The ► icon and track information will be displayed.
- (2) Press PLAY/PAUSE again during playback to pause. II is displayed. Press PLAY/PAUSE again to resume playback.
- (3) Press STOP to stop playback.
- (4) M3 is displayed when playing MP3.
- (5) Repeat tracks:
 - (a) "REP 1": Repeat the current track.
 - (b) "F": Repeat the tracks at current folder.
 - (c) "ALL": Repeat all tracks.
 - (d) REP disappears: Stop the repeat function.
- (6) SPEED: Allow track to play at an increased (HIGH) or decreased (LOW) speed or Normal speed. Speed can be adjusted in 10 different steps. NOR denotes normal speed.

(C) Operating instructions for the order of playing music:

- (1) Copy the desired songs into USB storage unit one by one until copying all the desired songs. By this way, the play sequence will be based upon the order of music being programmed into USB storage unit.
- (2) Number the desired songs when copying them into folders. Then copy the folders into USB storage unit. Please note the songs must be numbered by the same digit like 00, 01, 02 or 000, 001, 002 or 0000, 0001, 0002.. and so on.

(D) Record tracks:

- (1) If recording input signals are to be saved into a USB or SD Card, insert a USB or SD card into slot and ascertain the intended Source. Press RECORD **A11** and "WAIT REC" will be shown until "STANDBY" is flashing. Then press RECORD to start recording process. Press RECORD button to pause and press RECORD again to record. Press STOP **A12** to stop recording and it converts to MP3 format and saved in "REC" folder.
- (2) Recording input can be converted into MP3 (44.1KHz 128Kbps) file format. It can be saved into a USB or SD Card.
- (3) Press REC PLAY **A13** to play current recorded track.

(E) Play recorded tracks:

- (1) Press REC PLAY after the recording process, it will play the last recorded track. Press STOP and then press REC PLAY, it will play the first track of the REC folder.
- (2) Press REC PLAY to enter into recorded tracks. Press REV / F.WD to search for tracks.

Portable Wireless PA System

3. Remote Controller Controls. Fig. 16:

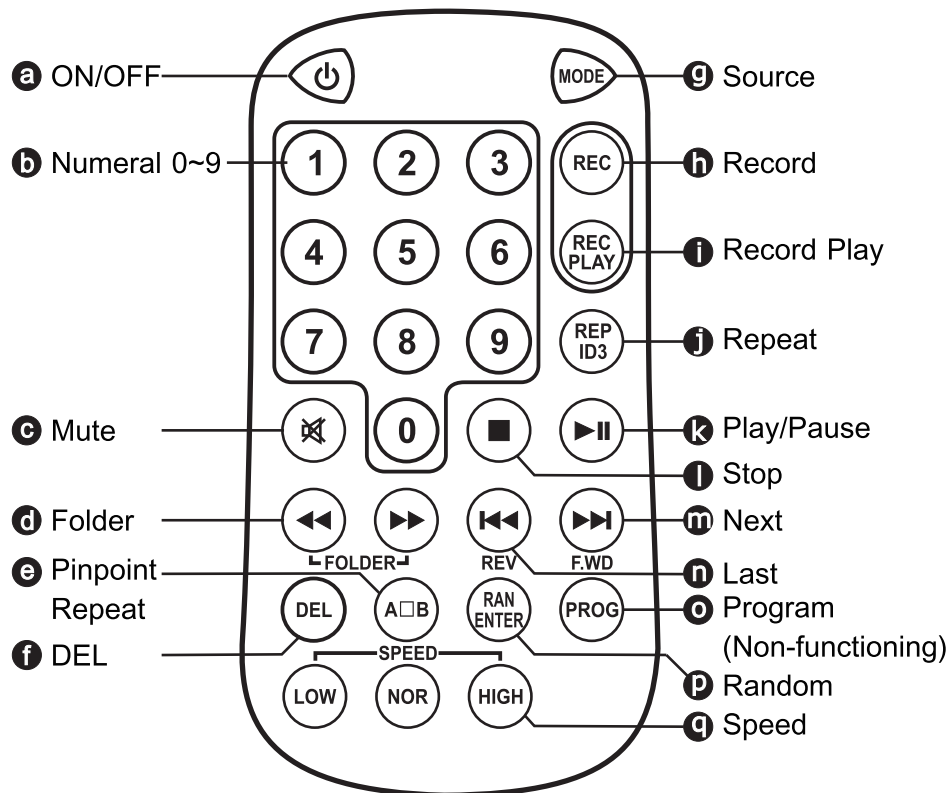

Fig. 16

4. Remote Controller Functions:

(A) MUTE: Press to mute, press again to un-mute.

(B) Pinpoint Repeat A→B: During playback, press A→B to pinpoint A. Press again to pinpoint B and start to pinpoint repeat playing between A and B. Press it again to cancel the function.

(C) DEL: Delete button. Select the to be deleted track during playback. Press DEL button, LCD displays DEL FILE. Press once to delete this track.

(D) RAN ENTER: Play random tracks. Press RAN ENTER to play randomly. Or use the REV or F.WD on the control panel or remote controller to play randomly.

(E) Numeric selection for tracks:

(1) For a lot of tracks, use the remote control number keys to directly go to the specified track. Here are some common examples.

(2) **1** → **3** → **4** : Press for track #134.

(3) **6** → **8** : Press and wait for 3 seconds for track #68.

(F) Other functions refer to the operating instruction of the control panel.

(G) Insert Battery to Remote Control. Fig. 17:

(1) Press down on the small left fixed latch and hold the right side of the battery seat groove gently to pull out the battery holder.

(2) Insert the new battery with the positive upward and gently push the battery holder inward to position it.

(3) Note: When using the remote control, the best reception distance is 3 meters from the remote control to the receiving hole on the control panel (effective distance is 5 meters).The battery of remote control is CR2025 3V battery.

Portable Wireless PA System

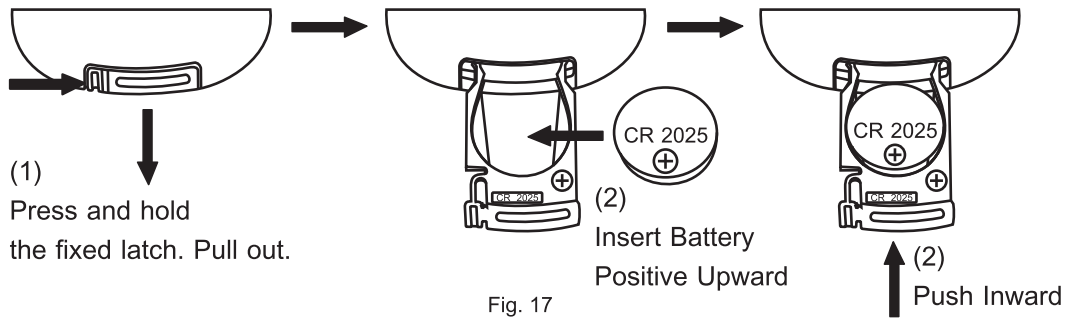

5. Notes:

- (A) Do not hit the player.
- (B) Do not place this player near strong magnetic fields and electric fields.
- (C) Do not disassemble, repair or modify this player.
- (D) Changes to the characteristics and design of the product will be made without notice.

X. Installation of Optional MIPRO CD/MP3 Player

1. Installation Steps. Fig. 18

- (A) Power off the system first.
- (B) Remove the protection cover panel.
- (C) Gently insert the CD/MP3 player module (optional) into the slot.
- (D) Make sure the back edge connector is aligned and firmly connected.
- (E) Tighten up the screws.

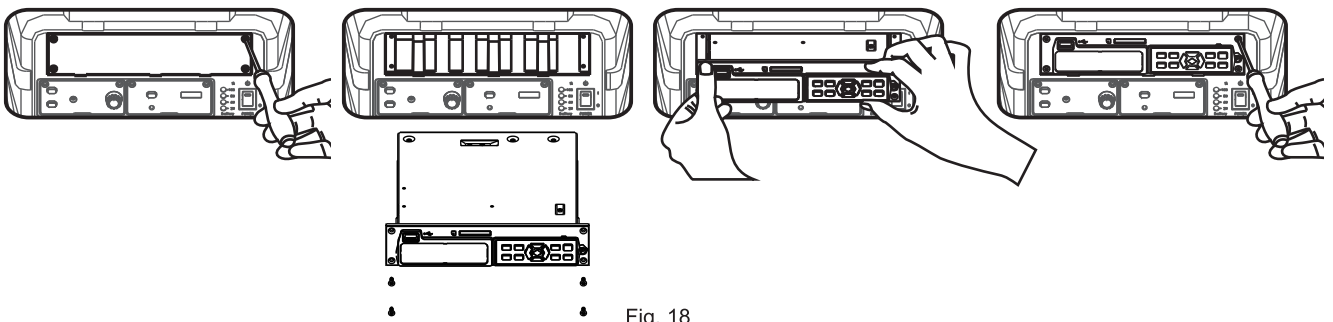

2. Operations of CD/MP3 Player: Refer to its user guide.



Portable Wireless PA System

XI. Helpful Operating Tips

1. We recommend placing sound system between the target audience and the presenter, facing the audience and raised above their heads using a speaker stand or tabletop. This set-up helps prevent the annoying feedback by keeping wireless & wired microphone users behind the sound system. The internal power supply rechargeable batteries should be kept fully charged. Always charge the system after use.
2. Minimized the Master Volume Control  before powering on. Adjust the volume controls afterward.
3. Each audio input is accepted through amplifier and its volume can be controlled separately.
4. Each audio input can be broadcasted and recorded at the same time.
5. MA-505 is equipped with professional wireless microphone system for premium sound.
6. NEVER place any wired or wireless microphone in front or close in front of the speaker otherwise feedback could occur.
7. This speaker fits into a standard speaker tripod stand.
8. Detached the power cord from AC power outlet once the system is fully-recharged.
9. Refer to operating instructions for wireless microphone system.
10. Refer to the actual product in the event of product description discrepancy.
11. Frequency range, output power and maximum deviation to comply with the regulations of different countries.

WARNING

1. FOR OUTDOOR USE:
To reduce the risk of fire or electric shock, do not expose this apparatus to rain or moisture.
2. UNDER WET LOCATION:
Apparatus should not be exposed to dripping or splashing and no objects filled with liquids, such as vases should be placed on the apparatus.
3. SERVICE INSTRUCTIONS:
CAUTION - These servicing instructions are for use by qualified service personnel only. To reduce the risk of electric shock, do not perform any servicing other than that contained in the operating instructions unless you are qualified to do so.

	
	This symbol indicates that dangerous voltage constituting a risk of electric shock is present within this unit.
	This symbol indicates that there are important operating and maintenance instructions in the literature accompanying this unit.

Portable Wireless PA System

Federal Communication Commission Interference Statement

This equipment has been tested and found to comply with the limits for a Class B digital device, pursuant to Part 15 of the FCC Rules. These limits are designed to provide reasonable protection against harmful interference in a residential installation.

This equipment generates, uses and can radiate radio frequency energy and, if not installed and used in accordance with the instructions, may cause harmful interference to radio communications. However, there is no guarantee that interference will not occur in a particular installation. If this equipment does cause harmful interference to radio or television reception, which can be determined by turning the equipment off and on, the user is encouraged to try to correct the interference by one of the following measures:

- ! Reorient or relocate the receiving antenna.
- ! Increase the separation between the equipment and receiver.
- ! Connect the equipment into an outlet on a circuit different from that to which the receiver is connected.
- ! Consult the dealer or an experienced radio/TV technician for help.

FCC Caution: To assure continued compliance, any changes or modifications not expressly approved by the party responsible for compliance could void the user's authority to operate this equipment. (Example - use only shielded interface cables when connecting to computer or peripheral devices).

FCC Radiation Exposure Statement

This equipment complies with FCC RF radiation exposure limits set forth for an uncontrolled environment. This equipment should be installed and operated with a minimum distance of 20 centimeters between the radiator and your body.

This transmitter must not be co-located or operating in conjunction with any other antenna or transmitter.

The antennas used for this transmitter must be installed to provide a separation distance of at least 20 cm from all persons and must not be co-located or operating in conjunction with any other antenna or transmitter.

THIS DEVICE COMPLIES WITH PART 74 AND PART 15 OF THE FCC RULES. This equipment complies with FCC RF radiation exposure limits set forth for an uncontrolled environment.

This device complies with Industry Canada licence-exempt RSS-123 ISSUE 2 and RSS-210 ISSUE 8 standard.

Operation is subject to the following two conditions: (1) this device may not cause interference, and (2) this device must accept any interference, including interference that may cause undesired operation of the device.

FC & IC - ID

THIS DEVICE COMPLIES WITH PART 15 OF THE FCC RULES AND RSS-123 ISSUE 2 OF CANADA. OPERATION IS SUBJECT TO THE FOLLOWING TWO CONDITIONS:

- (1) This device may not cause interference.
- (2) This device must accept any interference, including interference that may cause undesired operation of the device. This equipment complies with FCC RF radiation exposure limits set forth for an uncontrolled environment.

Disposal



2005-08-13

Dispose of any unusable devices or batteries responsibly and in accordance with any applicable regulations.

Disposing of used batteries with domestic waste is to be avoided!

Batteries/NiCad cells often contain heavy metals such as cadmium(Cd), mercury(Hg) and lead(Pb) that makes them unsuitable for disposal with domestic waste. You may return spent batteries/accumulators free of charge to recycling centres or anywhere else batteries/accumulators are sold.

By doing so, you contribute to the conservation of our environment!



® 201-180636

IMPORTANT SAFETY INSTRUCTIONS

1. Read these instructions.
2. Keep these instructions.
3. Heed all warnings.
4. Follow all instructions.
5. Do not use this apparatus near water.
6. Clean only with a dry cloth.
7. Do not block any ventilation openings. Install in accordance with the manufacturer's instructions.
8. Do not install near any heat sources such as radiators, heat registers, stoves, or other apparatus (including amplifiers) that produce heat.
9. Do not defeat the safety purpose of the polarised or ground plug: A polarised plug has two blades with one wider than the other. The wide blade is provided for your safety. When the provided plug does not fit into your outlet, consult an electrician for replacement of the obsolete outlet.
10. Protect the power cord from being walked on or pinched particularly at plug, convenience receptacles, and the point where they exit from the apparatus.
11. Only use attachments/accessories specified by the manufacturer.
12. Use only with a cart, stand, tripod, bracket, or table specified by the manufacturer, or sold with the apparatus. When a cart is used, use caution when moving the cart / apparatus combination to avoid injury from tip-over.
13. Unplug this apparatus during lightning storms or when unused for long periods of time.
14. Refer all servicing to qualified service personnel. Servicing is required when the apparatus has been damaged in any way, such as power-supply cord or plug is damaged, liquid has been spilled or objects have fallen into the apparatus, the apparatus has been exposed to rain or moisture, does not operate normally, or has been dropped.
15. If Service Instruction in Owner's Manual: "Caution - These servicing instructions are for use by qualified service personnel only. To reduce the risk of electric shock do not perform any servicing other than that contained in the operating instructions unless you are qualified to do so.
16. The equipment is a Class I apparatus, shall be connected to a mains socket outlet with a protective earthing connection.
17. Warning: To reduce the risk of fire or electric shock, do not expose this apparatus to rain or moisture and objects filled with liquids, such as vases, should not be placed on this apparatus.
18. To completely disconnect this apparatus from the ac mains, disconnect the power supply cord plug from the ac receptacle. Pour deconnecter completement l'appareil du reseau d'alimentation, deconnecter le cordon d'alimentation de la prise murale.
19. The mains plug of the power supply cord shall remain readily accessible. La prise du reseau d'alimentation doit demeurer aisement accessible.
20. Warning: Do not expose batteries or battery pack to excessive heat such as sunshine, fire or the like. Avertissement: Les batteries ou bloc de batteries ne doivent pas etre exposees a une chaleur excessive telle que celle du soleil, feu ou autre source de chaleur similaire.
21. Caution: Danger of explosion if battery is incorrectly replaced. Replace only with the same or equivalent type. Attention: Danger d'explosion si la pile n'est pas remplacée correctement. Ne remplacer que par le même type ou un type équivalent.



"This product can only be used at the area that the altitude is lower than 2000m for safety purpose."



"This product can be used in non-tropical locations only for safety purpose."